

VULCANO

BREAK

The modular system

Innovativo concetto modulare ideato e progettato dal nostro ufficio R&D per permettere un facile e rapido allestimento di aree colazioni, buffets, angoli caffè e molto altro. I banchi della linea BREAK sono studiati per essere totalmente modulari e composti a piacimento sulla base delle reali necessità del cliente o di eventuali vincoli presenti all'interno delle aree da allestire.

BREAK rende possibile ed elegante l'allestimento dei più svariati ambienti; dalle hall dei grandi hotel, alle sale riunioni e conferenze, alle piccole sale colazioni di alberghi familiari fino a terrazze e dehors di locali desiderosi di valorizzare e far risaltare le creazioni dei propri chefs.

Innovative modular concept designed by our R&D office to allow easy and quick set up of areas for the display and presentation of breakfasts, buffets, coffee corners and much more. BREAK counters are designed to be as much modular as possible and can be composed and linked together following the real needs of the customers.

BREAK makes the setting up of the most varied environments possible and elegant; from hotel halls, to conference and meeting rooms, to small breakfast corners of family hotels up to the rooftops and dehors of restaurants and clubs that want to highlight and enhance the creations of their chefs.



BREAK



PANNELLATURA RESISTENTE IN NOBILITATO IDROFUGO DISPONIBILE NEI COLORI DELLA NOSTRA GAMMA

STURDY HYDROPHOBIC LAMINATED WOOD PANELING, AVAILABLE IN OUR RANGE COLORS

RIPIANO REGOLABILE IN ALTEZZA
HEIGHT-ADJUSTABLE SHELF

2 RUOTE Ø 75 MM CON FRENO
2x Ø 75 MM POLYAMIDE WHEELS WITH BRAKE

STRUTTURA IN LAMIERA VERNICIATA AD ALTA RESISTENZA
POWDER COATED HIGH RESISTANCE STEEL STRUCTURE



SISTEMA DI COMPOSIZIONE MODULARE CLICK CATCH®
CLICK CATCH® MODULAR CONNECTING SYSTEM

Colori struttura - Structure colors



RAL 9010 (+ LNO)

BIANCO PURO (+ LAMINATO NOCE)
PURE WHITE (+ LAMINATED WALNUT)

Finitura liscia/lucida
Smooth-gloss finish

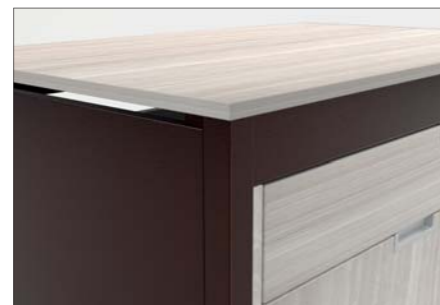

RAL 8017 (+ LWS)

CIOCCOLATO (+ LAMINATO SABBIA BIANCA)
CHOCOLATE (+ LAMINATED WHITE SAND)

Finitura liscia/lucida
Smooth-gloss finish

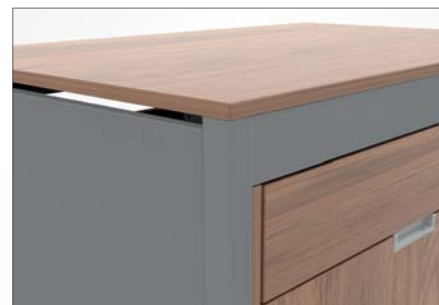

RAL 7037 (+ LOM)

GRIGIO (+ LAMINATO OLMO)
GREY (+ LAMINATED ELM)

Finitura bucciata/opaca
Textured-matt finish

La linea Break, oltre ad avere le pannellature in legno laminato disponibili in 21 decori, può avere la struttura in acciaio verniciata a polvere in 3 colori design.

The Break line, in addition to the 21 laminated wood panels decors, can have the metal structure in 3 powder coated design colors.

Prezzi - Prices

BREAK	Codice - Code	Descrizione e finitura	Description and finishing	Prezzo - Price
Legno laminato - Laminated wood				
BREAK	016MOBRK	Buffet neutro - Legno laminato	Neutral buffet module - Laminated wood	

Dati tecnici - Technical data

Dati tecnici - Technical data	BREAK
Peso Netto (Kg) Net Weight	58 *
Dimensioni imballo (cm) Packing size	135 x 92 x 150h

* Il peso complessivo può variare sensibilmente in base agli optional montati.
The total weight may vary according to the mounted optionals.

Disegno tecnico - Technical drawing

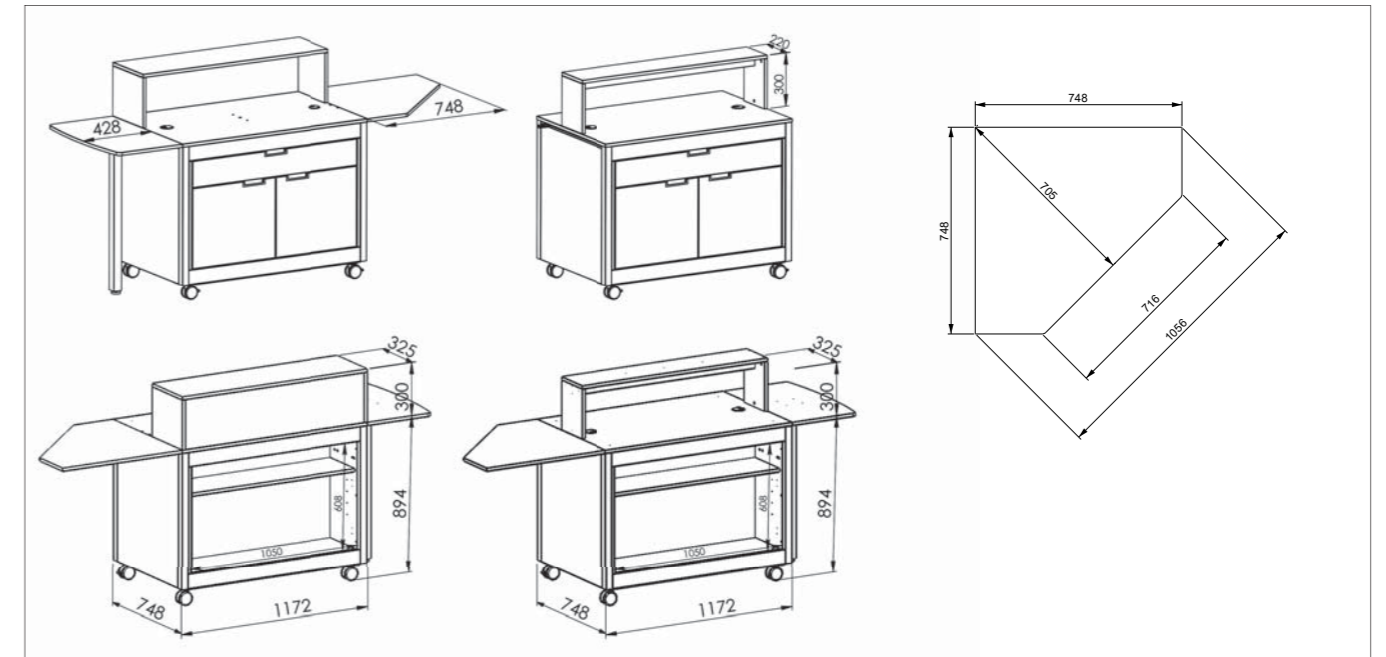

Configurazioni - Configuration

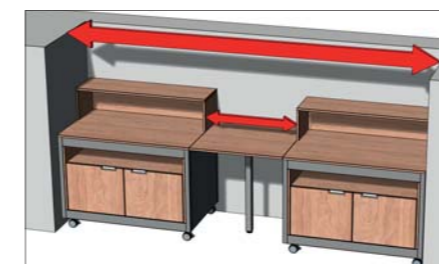
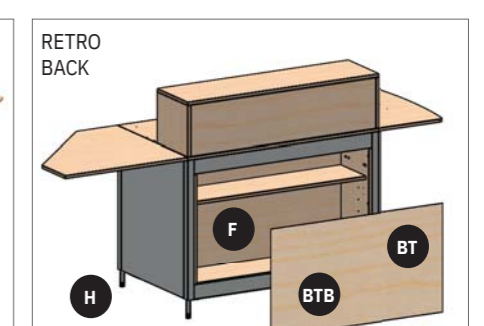
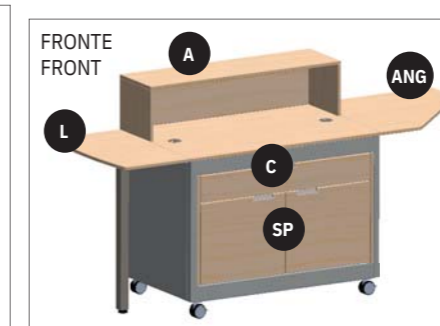
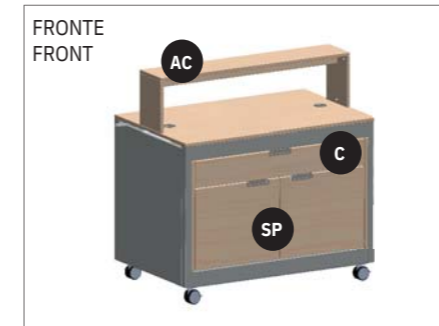

MODULO PER COSTRUZIONI SU MISURA CUSTOMIZED CONNECTION MODULE

Spesso gli spazi disponibili non sono perfettamente compatibili con le dimensioni standard del Break. Nel caso, Opt. L e Opt. ANG possono essere personalizzati/modificati in base ai tuoi bisogni.

Often the spaces available are not perfectly compatible with the standard dimensions of the Break. In case, Opt.L and Opt.ANG can be customized / modified according to your needs.

Pannellature - Paneling

LEGNO LAMINATO
LAMINATED WOOD



MATERIALI E DECORI - MATERIALS AND DECORS >> PAG. 324

Struttura - Structure

LAMIERA VERNICIATA
POWDER COATED



BREAK

OPTIONAL

OPTIONALS



A
ALZATA DI SERVIZIO POSTERIORE
SPLASHBOARD ON THE BACKSIDE



AC
ALZATA DI SERVIZIO CENTRALE
CENTRAL UPPER SHELF



BTB
PANNELLATURA POSTERIORE PARZIALE A FILO
BACK PARTIAL PANELING INSIDE STRUCTURE



ANG
MODULO ANGOLARE 90° (SOLO PIANO)
90° ANGLE MODULE (SHELF ONLY)



ANG/Q
MODULO ANGOLARE QUADRATO CON GAMBA
SQUARE ANGLE MODULE WITH LEG



LEG
GAMBA DI SUPPORTO (SOLO CON OPT. ANG)
SUPPORT LEG (COMBINED WITH OPT. ANG)



BT
PANNELLATURA POSTERIORE TOTALE A FILO
TOTAL BACK PANELING INSIDE STRUCTURE



C
CASSETTONE SINGOLO
SINGLE BIG DRAWER



C2
COPPIA DI CASSETTI
DOUBLE DRAWERS



L
ALLUNGO LATERALE CON GAMBA DI SUPPORTO
SIDE EXTENSION WITH SUPPORT LEG



P
RIPIANO REGOLABILE AGGIUNTIVO
ADDITIONAL HEIGHT-ADJUSTABLE SHELF



SP
COPPIA DI SPORTELLI
DOORS



C/POST
CHIUSURA POSTERIORE CASSETTI
BACK CLOSURE FOR DRAWERS



CK
KIT AGGANCI RAPIDI CLICK CATCH®
CLICK CATCH® MODULAR CONNECTING SYSTEM



E
PASSACAVI
DESK CABLE GLAND



SP/H
COPPIA DI SPORTELLI ALTI
FULL-HEIGHT DOORS



TOP
RIVESTIMENTO DEL PIANO IN ACCIAIO INOX
STAINLESS STEEL WORKTOP COVERING



TOP/A
RIVESTIMENTO DEL PIANO IN
ACCIAIO INOX CON OPT.A
STAINLESS STEEL WORKTOP
COVERING WITH OPT.A



F
PARETE DIVISORIA VERTICALE INTERNA
(COMPATIBILE CON OPT. SP E SP/H)
INNER VERTICAL PARTITION
(COMPATIBLE WITH OPT. SP AND SP/H)



H
PIEDINI REGOLABILI
HEIGHT-ADJUSTABLE FEET



Z
ZOCCOLINI
SKIRTING



TOP/AC
RIVESTIMENTO DEL PIANO IN
ACCIAIO INOX CON OPT.AC
STAINLESS STEEL WORKTOP
COVERING WITH OPT.AC



ADS
ADESIVO PER PERSONALIZZAZIONE
STICKERS WITH BESPOKE GRAPHICS



K
CHIUSURA CON CHIAVE
LOCKING WITH KEY

BREAK

OPTIONAL OPTIONALS

Optionals	Codice - Code	Descrizione	Finitura	Description	Finishing	Prezzo - Price
A	01600BRKA	Alzata posteriore	Legno laminato	Shelf on the backside	Laminated wood	
AC	01600BRKAC	Alzata centrale	Legno laminato	Central upper shelf	Laminated wood	
ADS	01400ADES	Adesivo per personalizzazione		Stickers with bespoke graphics		
ANG	01600BRKANG	Modulo angolare 90°	Legno laminato	Corner module 90°	Laminated wood	
ANG/Q	01600BRKANG/Q	Modulo angolare quadrato e gamba di supporto	Legno laminato	Squared angle with leg	Laminated wood	
BTB	01600BRKBTB	Pannello posteriore parziale a filo	Legno laminato	Back recessed partial paneling	Laminated wood	
BT	01600BRKBT	Pannello posteriore a filo	Legno laminato	Back recessed paneling	Laminated wood	
C	01600BRKC	Cassettoni singoli	Legno laminato	Single big drawer	Laminated wood	
C2	01600BRKC2	Coppia di cassetti	Legno laminato	Double drawers	Laminated wood	
C/POST	01600BRKC/POST	Chiusura posteriore cassetti	Legno laminato	Back closure for drawers	Laminated wood	
CK	01600BRKCK	Kit agganci rapidi		Click Catch® modular connecting system		
E	01600BRKE	Passacavo		Desk cable gland		
F	01600BRKF	Parete divisoria interna	Legno laminato	Inner vertical partition	Laminated wood	
GNZ	C01ALANG/80	Giunzione/angolo per zoccolini		Skirting, corner		
H	01600BRKH	Piedini con zoccolino	Alluminio	Height-adjustable feet and skirting	Aluminium	
L	01600BRKLAT	Allungo laterale	Legno laminato	Side extension	Laminated wood	
LEG	01600BRKLEG	Gamba di sostegno per angolare	Acciaio Inox	Support leg	Stainless steel	
P	01600BRKP	Ripiano aggiuntivo	Legno laminato	Additional height-adjustable shelf	Laminated wood	
SP	01600BRKSP	Coppia di sportelli	Legno laminato	Doors	Laminated wood	
SP/H	01600BRKSP/H	Coppia di sportelli alti	Legno laminato	Full-height doors	Laminated wood	
TOP	01600BRKTOP	Top Inox	Acciaio Inox	Stainless steel top (without upper shelf)	Stainless steel	
TOP/A	01600BRKTOPA	Top Inox (con opt. A)	Acciaio Inox	Stainless steel top (with opt. A)	Stainless steel	
TOP/AC	01600BRKTOPAC	Top Inox (con opt.AC)	Acciaio Inox	Stainless steel top (with opt. AC)	Stainless steel	
KSP	01600BRK/KSP	Chiusura chiave per sportelli SP		Locking with key for doors SP		
KSP/H	01600BRK/KSPH	Chiusura chiave per sportelli alti SP/H		Locking with key for full-height doors SP/H		
KC	01600BRK/KC	Chiusura chiave cassettoni C/cassetti C2 (x1)		Locking with key for big drawer C / drawer C2 (x1)		
KSP/C	01600BRK/KSPC	Chiusura chiave sportelli SP se opt. con cassetto C/cassetti C2 è presente		Locking with key for doors SP if opt. big drawer C/drawer C2 is present		
Z3	01400ZOCC/3	Zoccolino frontale		Skirting, front		
ZLAT	01400ZOCC/LAT	Zoccolino laterale		Skirting, side		

